



Viega drainage technology

A constant stream of new ideas.

viega



Viega.

CONNECTED IN QUALITY.

Viega is convinced: Quality is everything. Without quality, everything means nothing. That is why the company strives to exceed itself each and every day. By means of regular dialogue with its customers, by developing better products and service features and by an approach to the future that does not lose sight of its past.

Viega has been connected in quality for over 115 years. It all began with the vision of revolutionising installation technology. With over 4,000 employees and ten locations, we have progressed to become a global market leader in the installation technology sector while still remaining true to our principles and setting our own high standards.

It is of importance to Viega to support its customers in their daily work. To this end, it shares its knowledge with customers all over the world, matches materials, technology and comfort, takes time for quality management and invests in research and development. The result: a perfectly coordinated system providing customers fast and reliable access to over 17,000 products.

Quality is everything. Without quality, everything means nothing.



CONTENTS

6

Viega drainage technology in the bathroom:
Diving into pure quality of life.

8

Viega Advantix and Advantix Vario:
Design shower channels and wall drains.



18

Viega Advantix:
Bath drains as a modular system.



24

Viega shower and bathtub drain sets:
Convincing drain solutions.

26

Viega Tempoplex, Domoplex, Duoplex and Varioplex:
Shower tray sets for highest demands.

28

Viega Multiplex and Rotaplex incl. Trio, Trio F, Trio E:
Innovative bathtub drain sets.



34

Viega Eleganta, slotted and universal valves:
Odour traps and drain valves.

36

The product range.

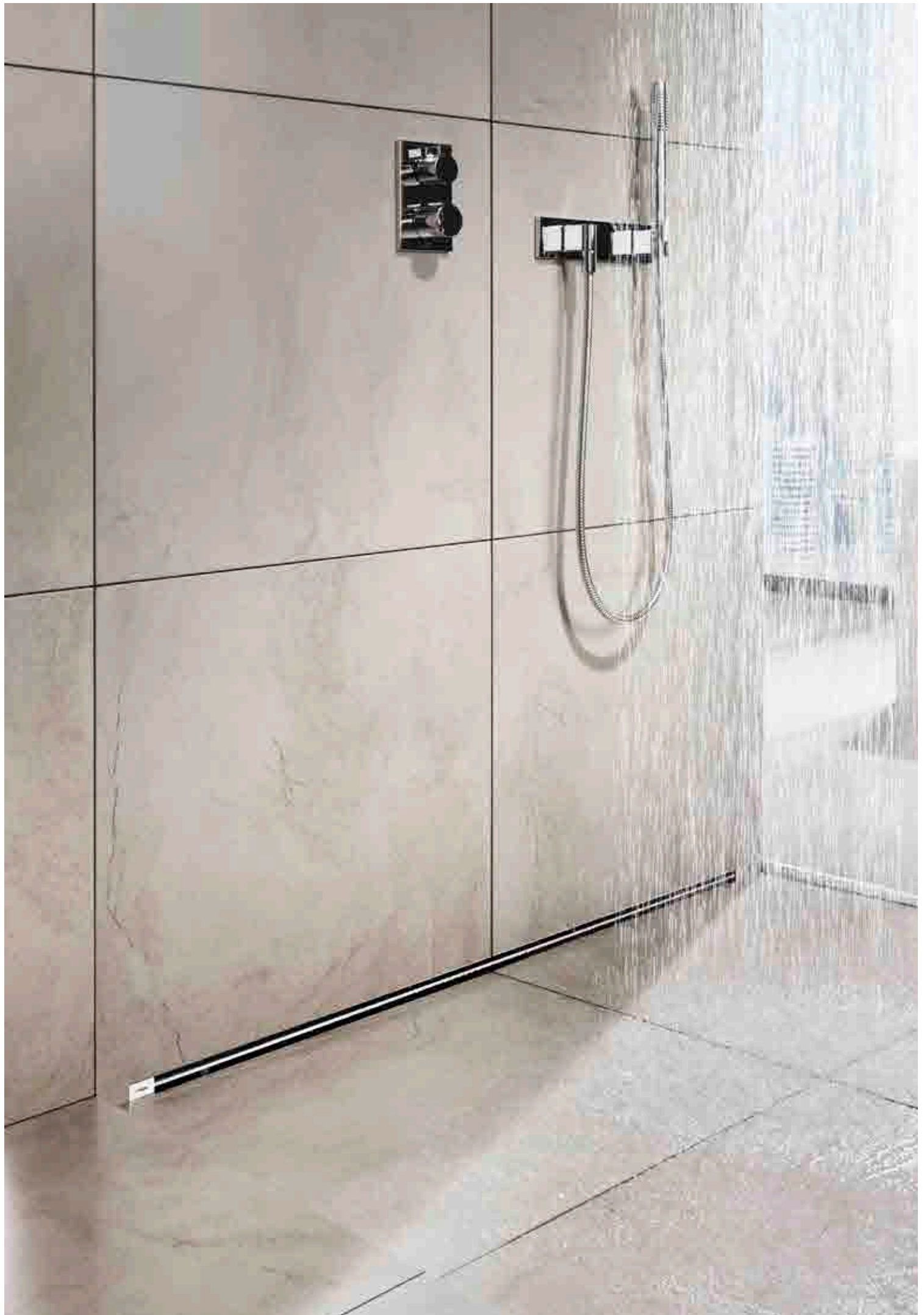

Viega drainage technology in the bathroom

DIVING INTO PURE QUALITY OF LIFE.

The bathroom has long been transformed from the functional “wet room” into a personal retreat. It has become a luxury spa where you can find calmness, relaxation and quality of life – surrounded by sophisticated design, high-grade materials and ground-breaking technology making the comfort bathroom of the new generation actually possible.

No matter whether a designer or multigenerational bathroom, floor-level shower or rain shower – the trend to more and more individuality calls for new technical ideas. A challenge Viega masters with confidence, the spirit of innovation and decade-long experience. Economical. Efficient. Reliable.

The Viega quality can be seen in the form, function, material, safety, and, last but not least, in the design. We have achieved the goal of our work only when aesthetics and performance join to form a perfect whole. To meet our exceptionally high demands, we connect first-rate engineers with renowned designers.

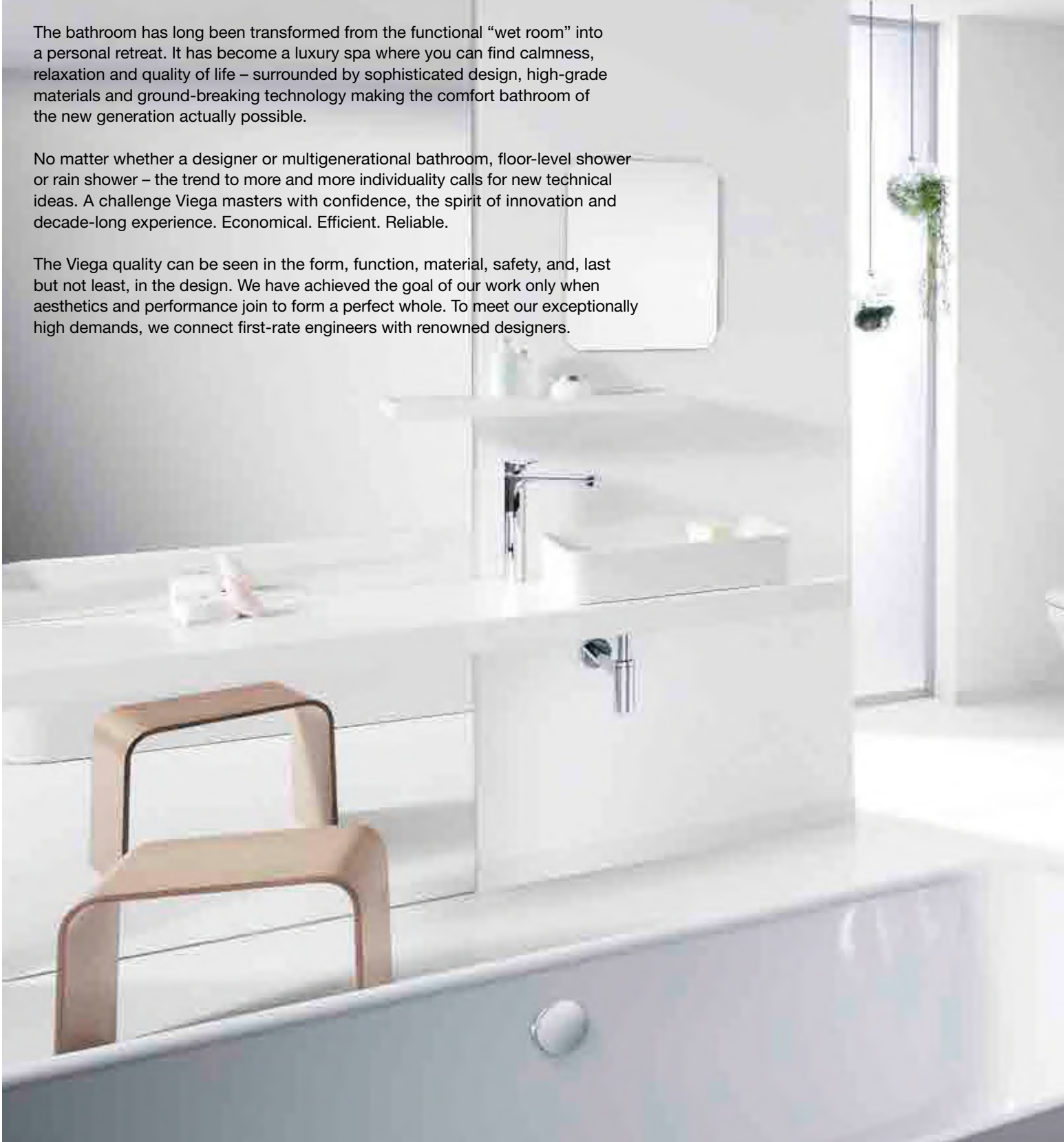

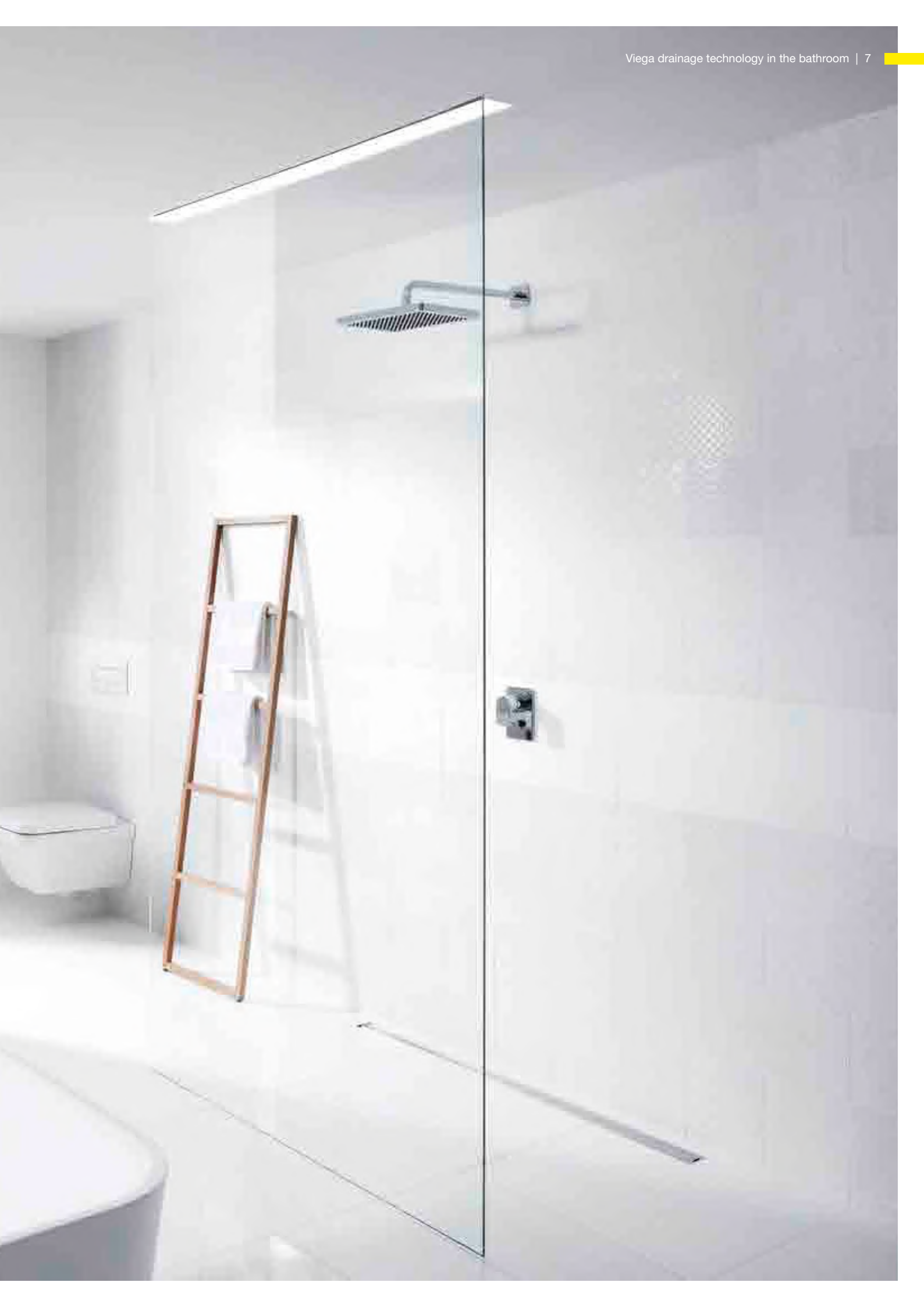



Viega Advantix shower channels

PERFECT DRAINS IN PLANNING AND INSTALLATION.

Can the perfect drain be achieved by a simple modular system? Or the highest variability by simple cutting to length or mounting at right angles? No problem with Viega floor drainage. The Advantix shower channel but also Advantix Vario as shower channel or wall drain convince by their first-class technology, a broad range coming up to every constructional situation and the multi-award winning design.

	Advantix Vario shower channel and wall drain	Advantix shower channel
Areas of use	Thanks to maximum flexibility tailor-made for individual solutions in the private area	Ideally suitable for public areas and high demands thanks to particularly robust quality
Material	Plastic	Stainless steel
Length	Shower channel: variable from 300–2,800 mm Wall drain: variable from 300–1,200 mm	Five lengths: 750, 800, 900, 1,000 and 1,200 mm
Height	Shower channel: variable from 95–150 mm Shower channel reconstruction model: 70–95 mm Wall drain: variable from 90–160 mm Wall drain reconstruction model: 70–100 mm	Depending on the drain variant at least 40, 70 or 95 mm
Installation variations	Shower channel freely in the room or arranged directly on the wall Wall drain Arrangement in the wall covering	One channel body respectively for free mounting or wall installation
Drainage capacity, measured at 10 mm water storage level above tiles	Depending on the installation situation between 0.4–0.8 l/s, when using several shower channels max. 2.4 l/s	Depending on the drain variant between 0.4 and 1.1 l/s
Design variants	Grates Stainless steel matt/polished Mounting frame Tile rail	Grates Square or round contour Tileable without rim or all-around rim Glass version in black or grey Mounting frame Square or round contour Standard
Sound protection according to DIN 4109 and VDI 4100	Shower channel Measured sound level 15 dB(A) Wall drain Measured sound level 12 dB(A) in "dry construction" wall Measured sound level 21 dB(A) or 17 dB(A) in "solid" wall	Measured sound level 19 dB(A)
Fire protection	Pipe lead-in R 120 Prevents the smoke and fire from spreading through the floor up to the resistance period of 120 minutes Art. No. 491 673	Pipe lead-in R 120 Prevents the smoke and fire from spreading through the floor up to the resistance period of 120 minutes Art. No. 491 673

Viega Advantix Vario

EVERYTHING FLOWS AS PLANNED.



Planning with the largest possible flexibility: Vario can both be installed in the wall and on the wall or freely in the room – optionally in straight shape, L or U shape, adapted to the architecture and the required drainage capacity. If refurbishment is intended, there is both the wall drain and the shower channel with the construction height of only 70 mm.

Possible design variants



Viega Advantix Vario models harmonically integrate in each bathroom with the total of four different colour variants. Black and white variants are available in addition to the classical stainless steel variants in matt and polished.



Standard model 4965.1 | Reconstruction model



Standard model 4967.10 | Reconstruction model

Two variants of the Advantix Vario shower channel are available: the standard version and the reconstruction model.

In addition to the Advantix Vario wall drain standard version there is also the reconstruction model.

Individual form and function of the shower channel

There are three different geometry options: firstly the simple straight one freely in the room or on the wall. Secondly the shower channel variant for mounting at right angles. Thirdly the U shape surrounding the entire shower area. All shapes can be implemented using the standard shower channel and few accessories. The drainage capacity can be doubled (Fig. 1) or even tripled up to 2.4 l/s by connecting two shower channels of the straight version or three channels of the U-shaped variant.

Exceptional planning with the wall drain

The Advantix Vario wall drain can be installed with a variable length from 300 to 1,200 mm, and also in three variants. Either placed freely in the wall, optionally on the right or left on the side wall or accurately fitting in the shower niche.

With its installation depth of only 25 mm the wall drain cannot only be installed in the wall covering of a solid wall (Fig. 2). It is also the ideal choice for the light-weight wall and pre-wall technology.

Quick selection by mouse click

The Advantix Vario configurator at the viega.com guides you to the right solution in a few clicks – it couldn't be easier!

Cleaning and hygiene comfort

The self-cleaning drain fittings ensure residue-free odour proof drainage under the discrete visual appearance of Vario. The narrow standing grates that are centred in the base unit without support feet contribute significantly to the hygiene comfort. They have to be taken out only to clean the smooth-walled drain profile with a cloth or brush (Fig. 3).



PLANNING ADVANTAGES

- Optimum flexibility in bathroom design
- Individual adaptation of length and drainage capacity by cutting to length or connecting shower channels
- Easy planning with Advantix Vario configurator
- Suitable for different installation situations
- Discrete design
- Easy cleaning facilitates usage in the private and public areas

Viega Advantix Vario

MOUNTED EASILY, QUICKLY AND SAFELY.



Advantix Vario end closing piece
Model 4965.16



Advantix Vario connection piece
Model 4965.12



Advantix Vario connection piece 90°
Model 4965.14

One package – all included

Viega Advantix Vario comes with everything required for mounting: from the handy saw guide for easy cutting to length, to tight connection pieces ensuring the permanently safe connection of several shower channels for example, up to special adhesive and sealing tape for the bonded sealing fit for practice.

One shower channel – any option

Advantix Vario also convinces by its variability during mounting: The design grate can be adapted to the given tile height from 5 to 20 mm. A protective foil on the flange and a hard foam block in the channel ensure cleanliness during installation. The narrow type of construction free of dead space render the shower channel and wall drain resistant to contamination.



The channel body can be cut to length within a few seconds using the saw guide and a hacksaw.



Advantix Vario even convinces as an elegant wall drain.



The tiler's set ensures that all required materials are at hand for the tiler completely and well packed.



The grate can be adjusted to the maximum tile height of 33 mm using the additionally available natural stone set (tile + adhesive).



BENEFITS FOR INSTALLATION

- Handy saw guide for easy cutting to length
- Tiler's set with special adhesive and sealing tape
- Design grate flexibly adjustable from 5 to 33 mm to the tile height
- Protective foil on the channel flange prevents contamination during installation
- Drain unit with flexible 45° connection elbow
- Individual design through using tile rails

Viega Advantix shower channel

FEWER COMPONENTS, MORE FLEXIBILITY FOR PLANNING.

Reduction is the magic word. This is not only true for the clear design actually fitting perfectly in each bathroom but also for the reduced constituents of the modular system. This makes planning particularly easy. Each one of the two channel models – for free installation or wall installation – can be combined

with all drains, mounting feet, mounting frames and design grates. It is certainly also possible to replace the grates later. It goes without saying that by each combination you are opting for convincing design, best quality and a system built to perform.

Base unit



Base unit for free-standing installation
in five lengths from 750–1,200 mm
Model 4982.10



Base unit for wall installation
in five lengths from 750–1,200 mm
Model 4982.20

Drains

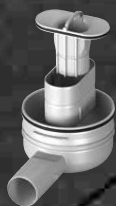

for construction heights from 95 mm,
drainage capacity: 0.5–0.55l/s*,
water seal level: 50 mm
(can be shortened to reconstruction model)
Model 4982.92



Reconstruction model for construction
heights from 70 mm, drainage capacity:
0.4–0.45l/s*, water seal level: 25 mm
Model 4982.93



vertical model for construction heights
from 40 mm, drainage capacity: 0.9–1.1 l/s*,
water seal level: 50 mm
(fire protection pipe lead-in possible)
Model 4982.94

Mounting feet



(with rubberised adjustable feet)
Model 4982.90



Reconstruction model
(with rubberised adjustable feet)
Model 4982.91

* Measured at the water level height of 10–20 mm above the tile.



YOUR ADVANTAGES FOR PLANNING

- Small drain with favourable flow conditions ensures good flushing and fewer cleaning intervals
- Easy cleaning of drain and profile also possible with the cleaning spiral
- Available in five lengths: 750, 800, 900, 1,000 and 1,200 mm
- Top quality material selection and workmanship
- Recent reduced design (40 mm), square or rounded in matt or high-gloss polished design, as a tile plate, tile trough, or glass version
- Frame in square contour, rounded contour or standard designs
- Satisfies the soundproofing requirements as per DIN 4109 and/or VDI 4100
- Viega Advantix pipe lead-in R 120 (accessories) as an optimal fire protection solution for floor lead-ins

Mounting frame

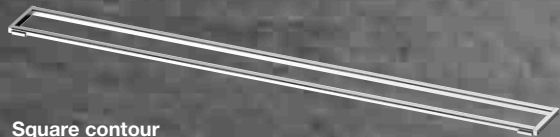

Square contour
Model 4982.30



Rounded contour
Model 4982.40

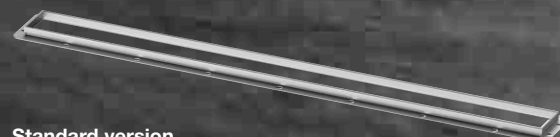

Standard version
of construction height 12 mm
Model 4982.45

Design grates



Visign ER10 square contour
(matt or high-gloss polished)
Model 4982.51



Visign ER11 rounded contour
(matt or high-gloss polished)
Model 4982.61



Visign ER12, tileable, rimless
Model 4982.71



Visign ER13, tileable, with all-round rim
Model 4982.70

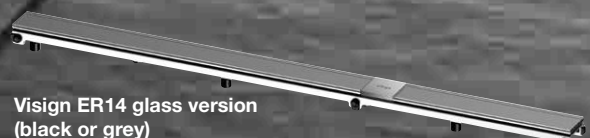

Visign ER14 glass version
(black or grey)
Model 4982.81

Viega Advantix shower channel

BASE UNITS FOR WALL OR FLOOR. BOTH EASY TO INSTALL.



Easy to install

Regardless whether floor or wall mounting: The Viega Advantix shower channel comes with everything needed for fast, smooth and clean mounting. All the flanges are sanded to guarantee optimal adherence of the bonded sealing. The standard model of the drain cannot only be rotated by 180° but also converted on site into a reconstruction model by simply cutting it to height.

Simply safe

For all other models the pipeline can be routed in parallel under the channel. They satisfy the sound protection requirements for the installation sound level as per DIN 4109 and VDI 4100. Advantix shower channels can be installed fire-proof in the floor construction with the Viega R 120 pipe lead-in up to the fire resistance duration of 120 minutes.



Sanded flanges to guarantee safe adherence of the bonded sealing.



The standard drain can be converted on site into a reconstruction model by simple cutting it to height.



Parallel routing under the channel ensures that the connection pipe does not go through the screed.



YOUR BENEFITS FOR INSTALLATION

- Simple, installation-friendly modular system
- Flexible for any installation situation
- Two channel models for free-standing or wall installation
- Three drains: standard, reconstruction and vertical model

Viega Advantix bath drains

PEAK PERFORMANCE IN EVERY SITUATION.

The Advantix bath drainage options with their sophisticated modular system offer the optimum solution for the greatest variety of applications: in the private bathroom with a shower on floor level, in sports facilities, WC and urinal facilities and saunas. All variants have in common high-quality materials, precise manufacturing, easy and safe installation and maintenance as well as high drainage capacities.

Grand appearance

Do you want a round design grate to bring organic shapes to your bathroom? Or do you prefer corners and edges being emphasised by a square grate? No problem with the Advantix bath

drains. Even discretely reduced corner drains are included in the vast range of products. All the design grates are made of high-grade stainless steel, available in different perforations, can be easily cleaned and are particularly

resistant to loads. Tileable design grates or the material mix of glass and stainless steel offer special highlights in addition to the classical grates.

Possible design variants



Visign RS11
Model 4962.1/4963.1



Visign RS14
Model 4962.4/4963.4



Visign RS15
Model 4976.30/4976.40



Visign EA1
Model 4972.30/4972.31



Visign RS2
Model 4928.2/4929.2

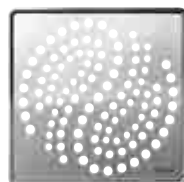

Visign RS4
Model 4928.4/4929.4



Visign RS5
Model 4976.10/4976.20

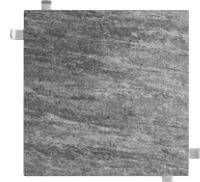

Advantix top, tileable
Model 4932.2

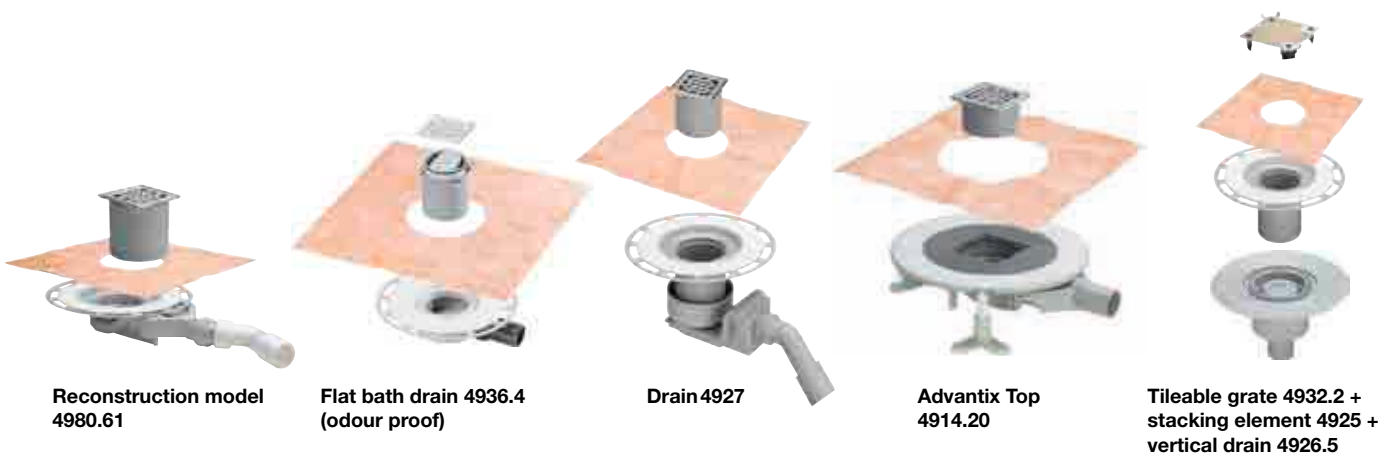

	Advantix bath drain 62 mm (reconstruction model) Model 4980.60/61/63	Advantix bath drain (odour proof) Model 4936.4	Advantix bath drain Model 4927/ 4927.1	Advantix Top bath drain Model 4914.20/2	Advantix bath drain Model 4932.2 + 4925 + 4926.5
Nominal width	DN 40/50	DN 50	DN 40/50	DN 50	DN 50
Construction height base unit (upper edge of the finished floor)	62 mm	70 mm	85–155 mm	85–120 mm	20–120 mm (stacking element)
Drainage capacity at accumu- lation height 10 mm/20 mm	0.5/0.55 l/s	0.35/0.4 l/s	0.4/0.55 l/s	0.75–1 l/s	0.7/0.9 l/s
Water seal level	25 mm	30 mm	50 mm	35–50 mm	50 mm
Water seal level adjustable on site	no	no	no	yes	no
Height adjustment of sealing flange after installation	no	no	yes	yes	yes
Unlimited use of all big grates	no	no	no	yes	no
Sound protection and floor fastening	no	no	no	yes	no

Viega Advantix bath drains

THE FLEXIBLE MODULAR SYSTEM FOR ALL FIELDS OF PLANNING.

For many decades now the Advantix product range has been continuously advanced by our engineers – with the outcome that the suitable drain can be offered for all planning interfaces.



Variable solutions

Advantix bath drains convince by their outstanding flexibility. The vast range offers solutions for all requirements regarding fire protection, sound protection and/or sealing and integrates in all installation situations – regardless whether wastewater is intended to be drained e.g. horizontally or vertically.

Quick planning

The Advantix configurator available at viEGA.com can be used to select the appropriate drain by a few mouse clicks: easily and time-saving.

Numerous variants

Compact single-part drains are available for a bonded sealing as well as stacking elements that can be shortened indi-

vidually. The latter ones are designed for being connected with different sealing levels, e.g. bitumen sealing lanes. The drains are certainly also available as reconstruction models for being used in existing buildings. The drain grates are optionally of 5-mm-thick stainless steel, glass, or can be tiled individually for a fully integrated visual appearance.

Odour protection

All drains are designed such as to offer safe odour protection by water seals. Odour proof drains such as the Advantix Top are available where odours are to be entirely prevented, such as high-grade bathroom reconstructions or hotels. In the event of negative pressure in the drainage system this model draws in

the necessary air through the drain – without the water seal being compromised.

Costs and benefits

Even high-grade bathroom architecture can be implemented economically when planning a tiled shower with a bath drain. What's more, bathing areas with a consistent use of materials remain visually elegant and individual thanks to such design simplicity. Advantix bath drains convince by their high flexibility in mounting, can be safely integrated in the bonded sealing, and easily cleaned.



Advantix Top drain, backflow-proof by a water seal barrier with centred pass-through opening and lateral back-flow pockets.



Fire protection drain R 120, vertical drain installation for flat construction heights and use in bonded sealing.



PROVEN BENEFITS

- Compact modular system for high-grade bathroom planning
- Intelligent sealing concept
- Highly hygienic thanks to easy cleaning
- Particularly economic and safe

Viega Advantix bath drains

INSTALLATION AND MOUNTING PRECISELY TO DIMENSIONS.

A bath drain must be installed technically precise, dimensionally accurate and as fast as possible. Therefore it is not surprising that the Advantix bath drains play on their advantage especially in installation and convince by the best material and manufacturing quality as well as many useful details ensuring fast and safe installation.

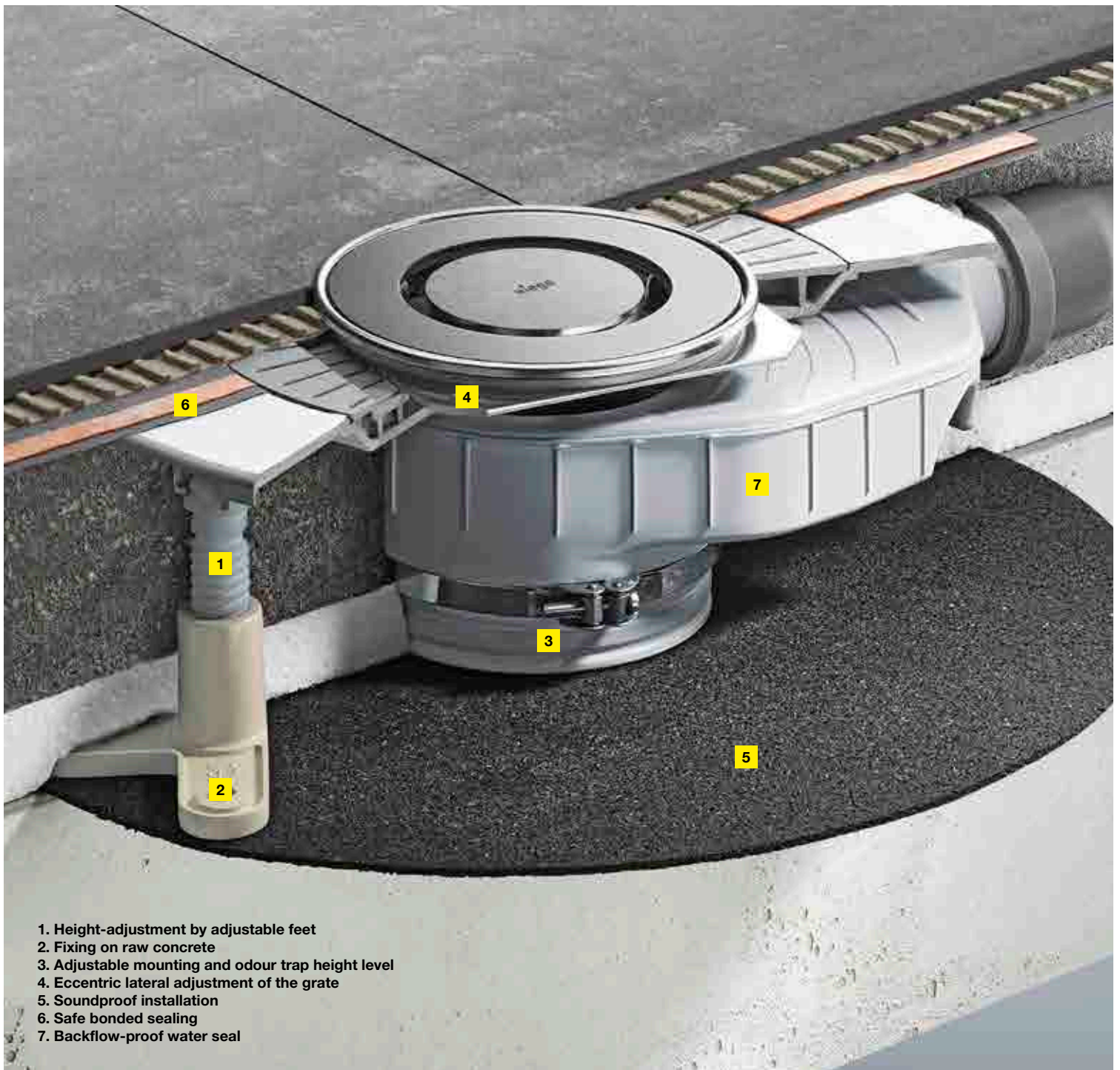

1. Height-adjustment by adjustable feet
2. Fixing on raw concrete
3. Adjustable mounting and odour trap height level
4. Eccentric lateral adjustment of the grate
5. Soundproof installation
6. Safe bonded sealing
7. Backflow-proof water seal

Flexible mounting

Deviations in the screed height often result subsequently with drains that shall be connected to a sealing level. This is where the drains with subsequent height adjustment of the sealing flange offer their unbeatable installation advantage (Fig. 1). The drain unit however can be installed on the raw concrete at an early date. In addition, the maximum water storage level in the drain offers a high drainage capacity. The drain casing comes with a ball joint and/or a 45° connection elbow for flexibility in all directions to additionally speed up installation of the pipe connection.



Easy to clean drain fitting model 4927 with flexible connection elbow, optionally for connection pipe 40 mm or 50 mm.

Sealing

No later than at the time of installation the following applies: Quality, especially the one of high-grade materials and state-of-the-art production processes, pays off. Special flanges with a level surface and the concept of the separate sealing collar guarantees the best-possible adhesion of the bonded sealing (Fig. 2).



Application of the 2nd sealing layer with a two-component plastic cement mortar combination proven in building practice.

Top drain

Advantix Top is perfectly equipped for all contingencies. It can be adjusted individually to the floor mounting level and fixed in position sound-proof – even subsequently. In addition, the drain comes with a backflow-proof odour trap and offers exact adjustment of the water seal level.



BUILD ON QUALITY

- Vast product range for individual installation solutions
- Safe sealing concept
- Flexibility in height adjustment and pipe connection
- Top technology combining all installation requirements

Viega shower and bathtub drain sets
INTELLIGENT DRAIN
SOLUTIONS.





A shower tray is still the first choice in many residential properties if an uncomplicated installation of shower comfort is concerned. Compared with tiled showers on floor level, shower trays are less expensive and installed faster. In addition they bring advantages in terms of hygiene thanks to their joint-free surface.

For individuals who prefer to bathe rather than shower, an integrated bathtub is a must-have feature. It converts a bathroom into a wellness spa where you can comfortably relax – correspondingly great is the demand for comfortable and attractive inlet, drain and overflow fittings for bathtubs.

Viega drainage solutions for shower trays and bathtubs combine the technical advantages with excellent design. As it comes to flexibility and safety in installation, they leave almost nothing to be desired. In short: Viega products are the number one choice when opting for premium quality.

Viega shower tray sets

MEETING HIGHEST DEMANDS ON DESIGN AND DRAINAGE CAPACITY.

The trend towards rain sky, flood and XXL showerheads continues. No problem for shower tray sets with a drainage capacity of up to 100% above standard. The high-quality manufactured design cover plates, being robust and having received multiple awards, make recent bathroom design child's play.

For flat shower trays and every installation situation

All the Tempoplex models come with a double drain seal, a robust stainless steel flange and an odour trap that can be removed and easily cleaned. Tempoplex Plus is 100% above standard with its drainage capacity and the particularly favourable flow properties. Tempoplex 60 is at 60 mm construction height and 30 mm water seal level perfectly suitable for refurbishments.

	Tempoplex	Tempoplex Plus	Tempoplex 60
Construction height	80 mm	80 mm	60 mm
Dia. drain hole	90 mm	90 mm	90 mm
Drainage capacity (at accumulation height 15 mm)	0.64 l/s	0.85 l/s	0.55 l/s



Tempoplex Model 6961



with vertical drain Model 6962



Tempoplex Plus Model 6960



Tempoplex 60 Model 6963



POINTS THAT ARE EVEN IMPRESSIVE

- Ideal for almost all flat shower trays with a 90-mm-drain
- Timeless: cover plate of flat design
- Safe installation thanks to robust stainless steel flange and double seal made of the same material as the one of the pipe connection technology
- Small space requirement below the shower tray
- Removable hood and removable odour trap insert for easy cleaning
- Access to drain line available



Viega Duoplex with extended standpipe

Domoplex
Model 6928Duoplex
Model 6934Varioplex
Model 6931.45

Three models for high shower trays and every requirement

In addition to the small construction height and fast installation Domoplex convinces above all by its optional vertical outlet or the 45° drain elbow, each with the diameter of 40 or 50 mm. While Duoplex comes with an extendable standpipe that can be used to accumulate water up to 90 mm, Varioplex uses a separate standpipe for the purpose. The odour trap that can be rotated by 360° additionally facilitates installation.

	Domoplex	Duoplex	Varioplex
Construction height	80 mm	110 mm	110 mm
Dia. drain hole	52 mm and/or 65 mm	52 mm	52 mm
Drainage capacity (at accumulation height 120 mm)	0.73 l/s	0.65 l/s	0.53 l/s



GOOD TO KNOW

- Materials and fixing technology proven for decades
- Fitting for all shower trays with a drain of 52 mm
- Drainage capacities higher than the required standard
- Small space requirement below the shower tray

Viega Multiplex and Rotaplex bathtub drain sets

TIMELESS DESIGN, INNOVATIVE TECHNOLOGY.

Small construction heights, high-quality finish, excellent design and convincing performances are only a few of the properties meeting the high requirements on the functional bathtub drain sets in bathroom design.

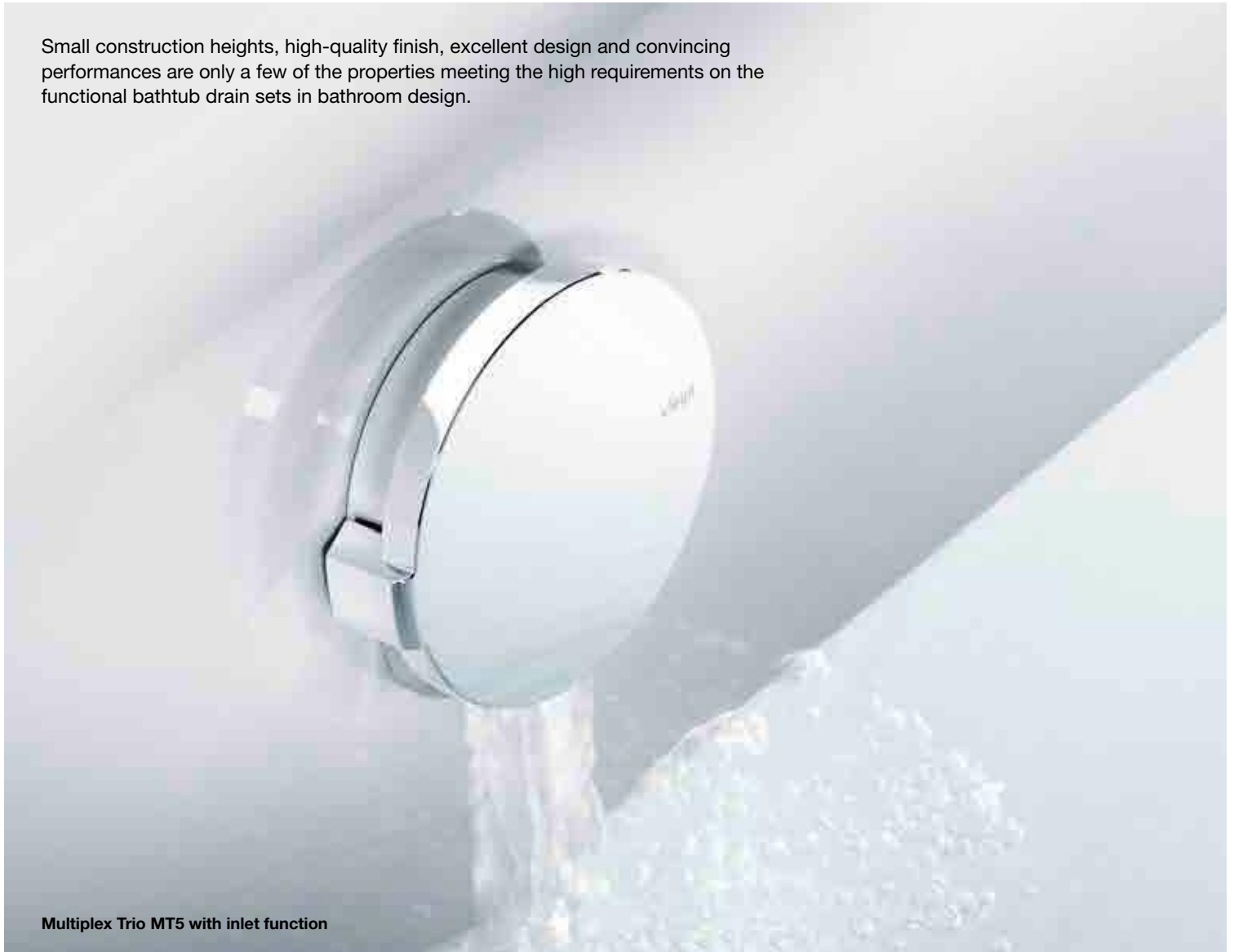

Multiplex Trio MT5 with inlet function

Possible design variants



M5, MT5, R5, RT5



M3, MT3, R3, RT3



M9/MT9



Multiplex Trio MT5, for drain holes 52 mm
Model 6161.50



Rotaplex Trio RT5, for drain holes 90 mm
Model 6141.60



	Multiplex Drain and overflow	Multiplex Trio Inlet, drain and overflow	Rotaplex Drain and overflow	Rotaplex Trio Inlet, drain and overflow
Installation depth	33 mm	33 mm	33 mm	33 mm
Dia. drain hole	52 mm	52 mm	90 mm	90 mm
Inlet capacity (at 2.5 bar)	–	0.33 l/s	–	0.33 l/s
Drainage capacity (at accumulation height 300 mm)	0.92 l/s	0.92 l/s	1.25 l/s	1.25 l/s
Overflow capacity (at accumulation height 60 mm over overflow hole centre)	0.63 l/s	0.63 l/s	0.63 l/s	0.63 l/s
Design rosettes	M5, M3, M9	MT5, MT3, MT9	R3, R5	RT3, RT5
Electric valve cone drive (for connection with Multiplex Trio E)	–	✓	–	✓



YOUR ADVANTAGES AT A GLANCE

- Three design variants are compatible with all functional units
- Straight-line water inlet adjusted to the design (Trio series only)
- Movable odour trap with higher drain capacity
- Small space requirement thanks to a flat rosette and narrow inlet element
- Available in three lengths for almost all bathtubs and requirements
- With its installation depth of 33 mm also suitable for narrow bathtub rims
- Easy mounting though flexibility at the overflow housing and optimised Bowden cable
- Adjustable flow control adaptable to the given situation on the overflow

Viega Multiplex Trio F and Rotaplex Trio F

NEAR-SILENT BATH FILLING FOR MAXIMUM COMFORT.

Multiplex Trio F and Rotaplex Trio F are not only real eye-catchers. They can also be hardly heard thanks to the innovative step of filling the bath from the bottom upwards. Inlet and drain are separate from each other and have backflow protection and a DVGW-certified pipe interrupter.



Jet-shaped bottom filling of Multiplex Trio F and Rotaplex Trio F

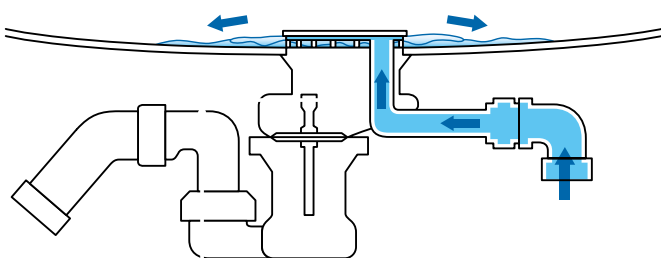

The inlet comes with a backflow preventer and pipe interrupter.

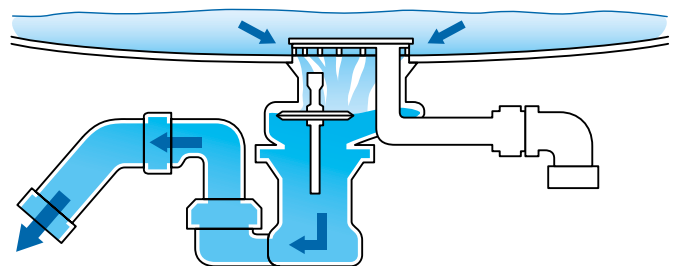

By opening the valve cone (can be electronically controlled if desired) the service water flows off as usual.



**Multiplex Trio F, for drain holes 52 mm
Model 6145.4**

**Rotaplex Trio F, for drain holes 90 mm
Model 6145.1**

	Multiplex Trio F	Rotaplex Trio F
Installation depth	33 mm	33 mm
Dia. drain hole	52 mm	90 mm
Inlet capacity (at 2.5 bar)	0.33 l/s	0.33 l/s
Drainage capacity (at accumulation height 300 mm)	0.85 l/s	1.0 l/s
Overflow capacity (at an accumulation height of 60 mm above overflow hole centre)	0.63 l/s	0.63 l/s
Electric valve (for connection with MT E-technology)	✓	✓



BENEFITS OF THE F SERIES

- Almost soundless tub filling system from floor level
- DVGW-certified concealed pipe interrupter included
- Small space requirement thanks to the flat rosette and narrow inlet
- Clear separation of inlet and drain
- Flat overflow housing of 33 mm, suitable for modern tubs with small rim
- Space-saving construction height of the odour trap (110 mm only)
- Different lengths for almost all bathtubs and design requirements
- Easy mounting thanks to the flexible overflow housing and optimised Bowden cable
- Movable odour trap with higher drain capacity

Viega Multiplex Trio E

FULLY AUTOMATIC FOR TOTAL RELAXATION.

The Internet of Things enters into the bathroom with Viega Multiplex Trio E. The intelligent control element can be controlled via WLAN and Internet suggesting risking driving safety? Simply by smartphone, tablet, PC or notebook.



Functions

Water temperature, inlet volume and fill level of the bathtub can be electronically controlled. Exactly, comfortable and even with the option of individually saving all the preferred temperatures, fill levels and quantities.

Control elements

Can be mounted fast and easily at any-place in the bathtub rim, on a dedicated platform or with the optional mounting set even outside the bathtub. Three versions of the control elements are available.

Mixing unit

Small, flexible and placeable entirely out of sight and serviceable any time without problems. The mixing unit can be combined with all drain and overflow fittings including the supply fittings of the Multiplex and Rotaplex series.

Control

Android, iOS or Windows – the smart remote control is compatible with all mobile terminal equipment. Access is via a browser without the need to install an app.



Multiplex Trio E3 control elements
Model 6146.215

Temperature settings and On/Off function are combined in the chromium control element. In addition it is possible to regulate the water flow volume.



The rotatable display element shows individual preset values, water temperature and water flow volume. Gently pressing the element will open the user menu with additional functions.



Multiplex Trio E2 control elements
Model 6146.2

Control is by two chromium control elements. One element is used for the water temperature including the illuminated ring and the other one for the On/Off function.



The other element serves to control the water flow volume and the changeover to hand shower.



Multiplex Trio E control element
Model 6146

All the functions such as temperature control, water flow volume or changeover to hand shower are controlled via a central control element.



Multiplex Trio E WLAN module

All the functions can be controlled by remote control via mobile terminal equipment.



AUTOMATICALLY CONVINCING

- Remote-controllable by smartphone, tablet, PC or notebook
- Large scope to implement design ideas – the visible part of the operating unit requires only small space
- Mounting on the bathtub rim or on the wall using the extension set
- Fully automatic control of water temperature, inlet volume, fill level – even from the road
- Memory function to save individual settings
- Automatic filling of the bathtub when calling-up the memory function
- Particularly safe thanks to the active overflow protection
- “Invisible” arrangement on mixing technology

Viega odour traps and drain valves

DESIGN AND TECHNOLOGY KNOWING ALL THE INS AND OUTS.



The Eleganta odour trap and the intelligent Visign drain valves proves yet again that even classical fittings can be beautifully designed and at the same time convincingly powerful.

Possible design variants



Eleganta
Model 5788



Eleganta set
Model 5788.4



Bottle odour trap
Model 5753



Pipe odour trap
Model 5611



Odour trap
Model 5421



Pipe odour trap
Model 5535

Odours can hardly be kept under a seal more beautiful

High-gloss chromium-plated brass, bottle or pipe shape – and all of them with optimum flow characteristics and integrated odour barrier: There is the ideal solution for every bathroom when it comes to odour traps.

Drain valves you cannot ignore

The Viega universal and slotted valves are either not lockable or available with innovative click-mechanism. Closing and opening is typically by gently pressing the cover.



Possible design variants



**Slotted valve
Visign V1
Model 5432/5433**



**Slotted valve
Visign V1
Model 5430/5431**



**Universal valve
Visign V1
Model 5438/5439**



**Universal valve
Visign V1
Model 5439.5**



**Universal valve
Model 5125**



**Universal valve
Model 5121**



WHAT THE PROFESSIONAL SHOULD KNOW

- High-grade design
- Easy and speedy installation
- Durable chromium surface
- Proven sealing material tried and tested a million times in pipe connection technology

Viega drainage technology in the bathroom

THE PRODUCT RANGE.

Viega's broad product scope for bathroom drainage offers high-quality technology and excellent design for virtually every area: from bathtub drain sets over shower channels and wall drains, drainage of shower trays and washbasins up to bathroom and floor drains. Special attention is certainly given to the best possible flexibility, quality and performance.

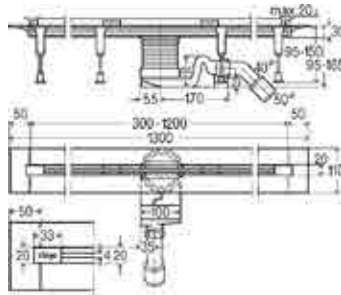

Advantix Vario shower channel
for bonded sealing
made of plastic
Base unit, model 4965.10
Standing grate matt, model 4965.30

Construction height 95–150 mm
Water seal level 50 mm
Drain DN 40/50

optionally the reconstruction model,
Base unit, model 4966.10



Advantix Vario connection piece
for connection of two shower channels
Model 4965.12

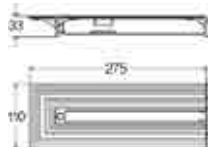

Advantix Vario end closing set
for extension of the Vario base unit
Model 4965.16

optionally the reconstruction model,
Model 4966.16

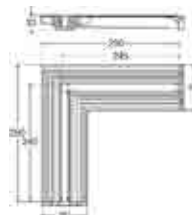

Advantix Vario connection piece 90°
for connection of two shower channels
Model 4965.14

optionally the reconstruction model,
Model 4966.14

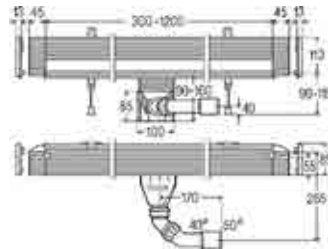

Advantix Vario wall drain
 for bonded sealing
 made of plastic
 Base unit, model 4967.10
 Grate, model 4967.30

Construction height 90–160 mm
 Water seal level 50 mm
 Drain DN 40/50

optionally the reconstruction model,
 Base unit, model 4968.10

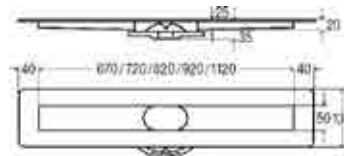

Advantix shower channel (modular system)
 for bonded sealing, made of stainless steel
 Sand-coated sealing flange
 Base unit, model 4982.10
 Odour trap, model 4982.92
 Adjusting feet set, model 4982.90
 Grate ER10 matt, model 4982.50

Construction height from 95 mm
 Water seal level 50 mm
 Drain DN 40 with adapter to DN 50

optionally odour trap
 Vertical, model 4982.94
 Reconstruction, model 4982.93
 Adjusting feet for recon., model 4982.91

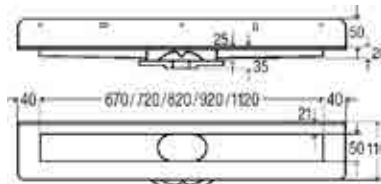

Advantix wall shower channel (modular system)
 for bonded sealing
 made of stainless steel, sealing flange sanded
 Base unit, model 4982.20
 Odour trap, model 4982.92
 Adjusting feet set, model 4982.90
 Grate ER11 matt, model 4982.60

Construction height 100 mm
 Water seal level 50 mm
 Drain DN 40 with adapter to DN 50

optionally odour trap
 Vertical, model 4982.94
 Reconstruction, model 4982.93
 Adjusting feet for recon. model 4982.91



Advantix mounting frame
 Square contour
 Model 4982.30

optionally rounded contour
 Model 4982.40

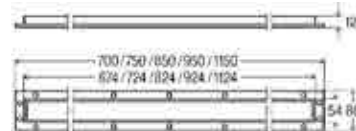

Advantix mounting frame
 Standard
 Model 4982.45

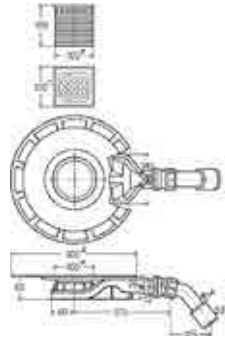

Advantix bath drain 62 mm
for bonded sealing
Model 4980.61

Construction height 62 mm (reconstruction drain)
Top with frame made of stainless steel and grate
Water seal level 25 mm
Drain DN 40/50



Advantix bath drain 70 mm
for bonded sealing
Model 4939

Construction height 70 mm
Top with frame made of stainless steel and grate
Water seal level 30 mm
Drain DN 50

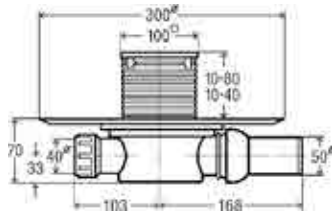

Advantix bath drain 70 mm odour proof
for bonded sealing
Model 4936.4

odour proof solution
Construction height 70 mm
Top with frame made of plastic or stainless steel and grate
Water seal level 30 mm
Drain DN 50

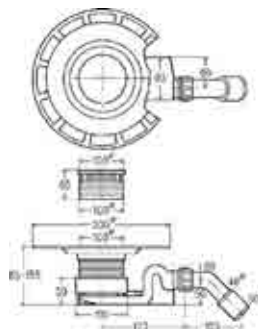
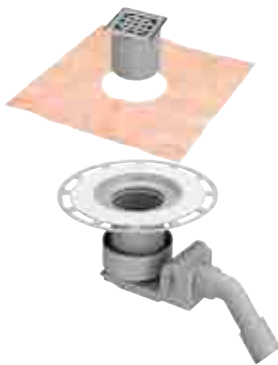

Advantix bath drain 85 mm
for bonded sealing
Model 4927

Construction height 85–155 mm
Top with frame made of stainless steel and grate
Water seal level 50 mm
Drain DN 40/50

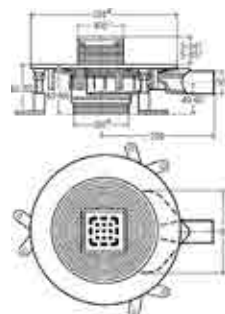

Advantix Top bath drain 85 mm
for bonded sealing
Model 4914.20

Construction height 85–120 mm
Top with frame made of plastic or stainless steel and grate
Water seal backflow-proof and adjustable from 35–50 mm
Drain DN 50

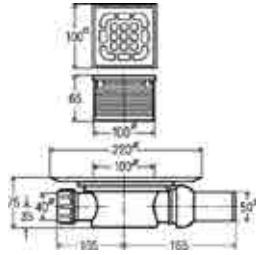

Advantix bath drain
for conventional sealing
Model 4935.1

Construction height 75 mm
Top with frame made of plastic
and stainless steel grate
Water seal level 50 mm
Drain DN 50

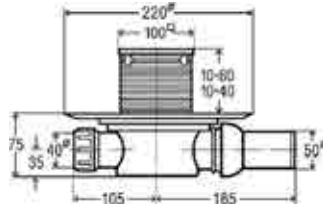

Advantix bath drain odour proof
for conventional sealing
odour proof solution
Model 4936.2

Construction height 75 mm
Top with frame optionally with plastic
or stainless steel grate
Water seal level 50 mm
Drain DN 50

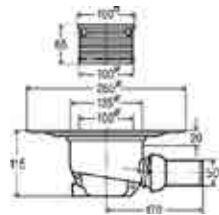

Advantix bath drain
for conventional sealing
Model 4921.76

Construction height 115 mm
Top with frame made of plastic
and stainless steel grate
Water seal level 50 mm
Drain DN 50

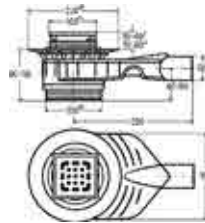

Advantix Top bath drain
for conventional sealing
Model 4914.10

Construction height 90–110 mm
Top with frame made of plastic
or stainless steel and grate
Water seal backflow-proof and
adjustable from 35–50 mm
Drain DN 50

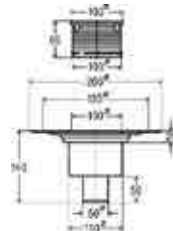

Advantix bath drain
for conventional sealing
Model 4926

Construction height 140 mm
Top with frame made of plastic
and stainless steel grate
Water seal level 50 mm
Drain DN 50

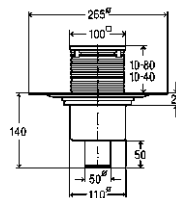

Advantix bath drain odour proof
for conventional sealing
odour proof solution
Model 4936.3

Construction height 140 mm
Top with frame made of plastic
Water seal level 30 mm
Drain DN 50

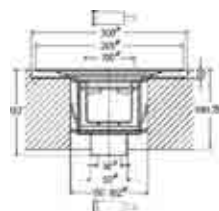

Advantix bath drain R 120
(Fire resistance class F30–F120)
Model 4926.20

Construction height 140 mm
Water seal level 50 mm
Drain DN 50
optionally stainless steel grate
with frame made of plastic, model 4934.1
with frame made of stainless steel, model 4934.2

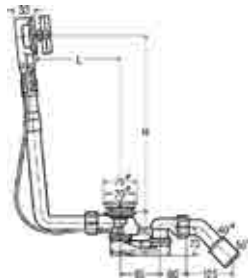

Multiplex drain and overflow

Visign M5
Model 6162.45

Water seal level 50 mm
Outlet DN 40/50
L 100–260, H 180–400

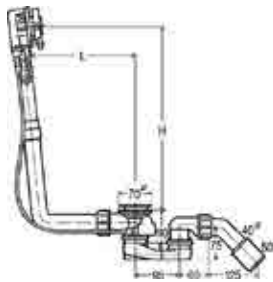

Multiplex Trio drain/overflow
for water inlet through overflow unit

Visign MT5
Model 6161.52
Equipment set model 6161.01

Water seal level 50 mm
Outlet DN 40/50
L 100–260, H 180–400

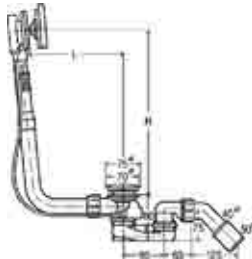

Multiplex Trio drain/overflow

for water inlet through overflow unit
with elevation of water level by 5 cm
Visign MT9
Model 6170.10

Water seal level 50 mm
Outlet DN 40/50
L 100–260, H 180–400

Also available as Multiplex
Model 6171.10

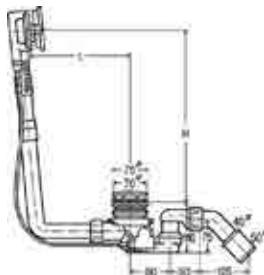

Multiplex Trio F drain/overflow

for water inlet through drain unit
Model 6145.4

Water seal level 50 mm
Outlet DN 40/50
L 100–260, H 180–350

Also available as Rotaplex Trio F
Model 6145.1

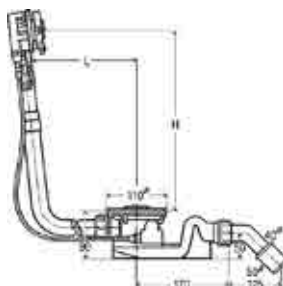

Rotaplex Trio drain/overflow

for water inlet through overflow unit
Visign RT5
Model 6141.62
Equipment set model 6141.01

Water seal level 50 mm
Outlet DN 40/50
L 150–400, H 180–430

Also available as Rotaplex
Model 6141.62 + equipment set
Model 6141.01

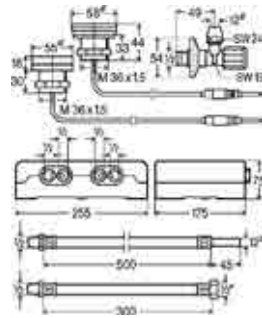

Multiplex Trio E3 fitting
Electronic mixing unit
with two control elements
Model 6146.215

Chrome-plated control element
Chrome-plated display element
with glass surface

Also available with one control element
Model 6146
Also available with two control elements
Model 6146.2



Multiplex Trio E WLAN module
for remote control of Multiplex Trio E through
mobile terminal equipment (Android, iOS,
Windows) in direct operation or via the internet

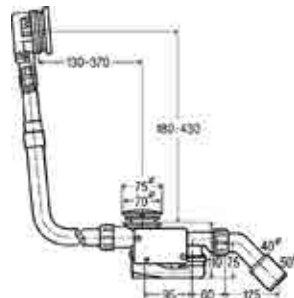

Multiplex Trio drain/overflow
for water inlet through overflow unit
with electric valve cone actuation
Model 6175.1

Water seal level 50 mm
Outlet DN 40/50

Also available as Rotaplex Trio
Model 6175.2

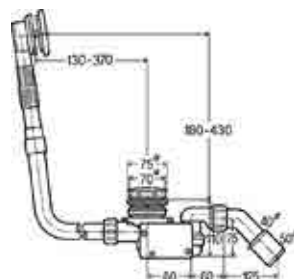

Multiplex Trio F drain/overflow
for water inlet through drain unit
with electric valve cone actuation
Model 6148.1

Water seal level 50 mm
Outlet DN 40/50

Also available as Rotaplex Trio version
Model 6148.2

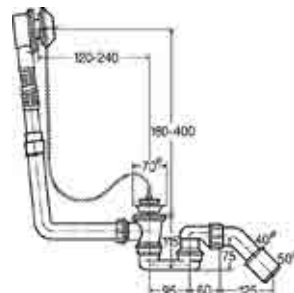

Citaplex drain and overflow
Stainless steel rosette
Model 6176.45

Water seal level 50 mm
Outlet DN 40/50

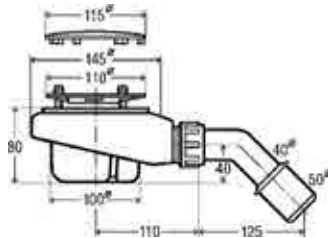

Tempoplex drain

for shower drains with drain hole \varnothing 90 mm
with chrome-plated cover plate
Stainless steel fixing flange
Model 6961

Water seal level 50 mm
Outlet DN 40/50

Also available as a vertical version
Model 6962

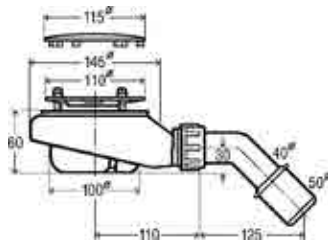

Tempoplex drain

Construction height 60 mm
for shower drains with drain hole \varnothing 90 mm
with chrome-plated cover plate
Stainless steel fixing flange
Model 6963

Water seal level 30 mm
Outlet DN 40/50

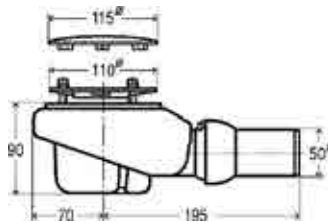

Tempoplex Plus drain

high drainage capacity
for shower drains with drain hole \varnothing 90 mm
with chrome-plated cover plate
Stainless steel fixing flange
Model 6960

Water seal level 50 mm
Outlet DN 50

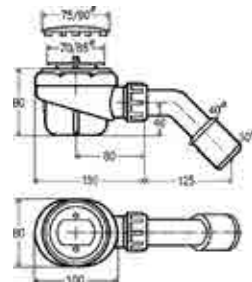

Domoplex drain

for shower drains with drain hole \varnothing 52 mm
with chrome-plated cover plate
Stainless steel fixing flange
Model 6928

Water seal level 50 mm
Outlet DN 40/50

Also available as a vertical version
Model 6921

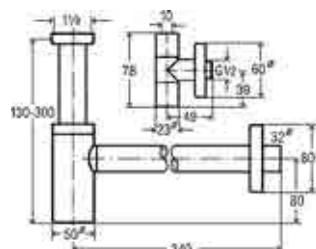

Eleganta set 1 – bottle odour trap

with Eleganta corner valves
chrome-plated brass
Model 5788.4

Water seal level 50 mm
Connection DN 32 mm

Also available without corner valves
Model 5788

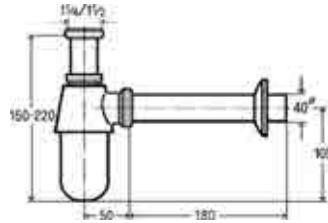

Bottle odour trap
 Chrome-plated brass
 Model 5763

Water seal level 50 mm
 Connection DN 32 mm

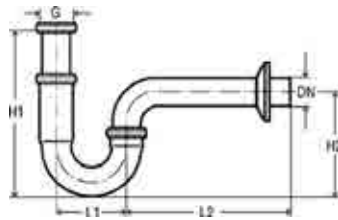

Pipe odour trap
 Chrome-plated brass
 Model 5611

Water seal level 50 mm
 Connection DN 32 mm
 L1 75, L2 170, H1 140–190, H2 115 mm

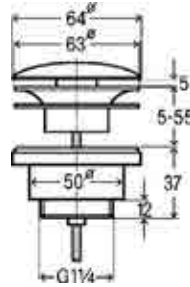

Universal valve
 Visign V1
 with round click-close cover
 Connection 1 1/4
 Model 5439

Also available with square cover
 Model 5441

Also available in various other versions

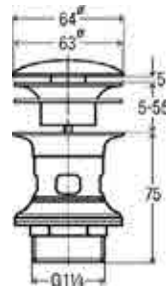

Slotted valve
 Visign V1
 with round click-close cover
 with overflow slots
 Connection 1 1/4
 Model 5433

Also available with stationary cover
 Model 5432

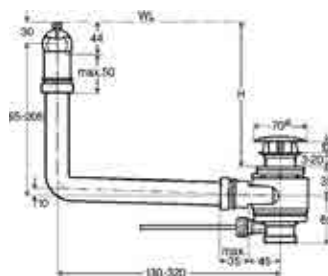

Drain/overflow
 with integrated overflow function
 for WB without overflow
 Connection 1 1/4
 Model 5420.1

INT 760 175-11/17-117617 · We reserve the right to effect changes.



Viega Holding GmbH & Co. KG

Viega Platz 1
57439 Attendorn
Germany

Phone +49 (0) 2722 61-0

viega.com

